



PU-IR01-KIT

Infra Red over CAT5e/6 Extender Set

OPERATION MANUAL

DISCLAIMERS

The information in this manual has been carefully checked and is believed to be accurate. CYP (UK) Ltd assumes no responsibility for any infringements of patents or other rights of third parties which may result from its use.

CYP (UK) Ltd assumes no responsibility for any inaccuracies that may be contained in this document. CYP (UK) Ltd also makes no commitment to update or to keep current the information contained in this document.

CYP (UK) Ltd reserves the right to make improvements to this document and/or product at any time and without notice.

COPYRIGHT NOTICE

No part of this document may be reproduced, transmitted, transcribed, stored in a retrieval system, or any of its part translated into any language or computer file, in any form or by any means—electronic, mechanical, magnetic, optical, chemical, manual, or otherwise—without express written permission and consent from CYP (UK) Ltd.

© Copyright 2019 by CYP (UK) Ltd.

All Rights Reserved.

Version 1.1

TRADEMARK ACKNOWLEDGMENTS

All products or service names mentioned in this document may be trademarks of the companies with which they are associated.

SAFETY PRECAUTIONS

Please read all instructions before attempting to unpack, install or operate this equipment and before connecting the power supply.

Please keep the following in mind as you unpack and install this equipment:

- Always follow basic safety precautions to reduce the risk of fire, electrical shock and injury to persons.
- To prevent fire or shock hazard, do not expose the unit to rain, moisture or install this product near water.
- Never spill liquid of any kind on or into this product.
- Never push an object of any kind into this product through any openings or empty slots in the unit, as you may damage parts inside the unit.
- Do not attach the power supply cabling to building surfaces.
- Use only the supplied power supply unit (PSU). Do not use the PSU if it is damaged.
- Do not allow anything to rest on the power cabling or allow any weight to be placed upon it or any person walk on it.
- To protect the unit from overheating, do not block any vents or openings in the unit housing that provide ventilation and allow for sufficient space for air to circulate around the unit.

REVISION HISTORY

VERSION NO.	DATE	SUMMARY OF CHANGE
v2.00	02/07/2019	First release

CONTENTS

1. Introduction	6
2. Applications	6
3. Package Contents	6
4. System Requirements	7
5. Features	7
6. Operation Controls and Functions	8
6.1 Transmitter Front and Rear Panels.....	8
6.2 Receiver Front and Rear Panels	9
6.3 IR Cable Pin Definition	10
6.4 IR Phone Jack Pin Definition	10
6.5 IR IN Pin Assignment	12
6.6 IR OUT Pin Assignment.....	12
6.7 RJ45 Pin Assignment.....	12
7. Connection Diagram	13
8. Specifications	14
9. Acronyms	15

1. INTRODUCTION

The IR Extender and the IR Repeater Box are perfect for controlling source devices over long distances using CAT5 Cable.

By using the built-in IR Receiver of the IR Repeater, users are able to control up to five sources (with the original remote controls) at the same time at a distance of up to 250 m.

There are no space limitations with these devices, which means even if the sources are in a different room or even another floor than the display, the performance stays the same.

The IR Extender and the IR Repeater Box give users an easy and convenient way to control their desired source. If however, users only wish to control sources in the same room then the IR Repeater Box will be enough to control up to 2 sources.

The IR Extender Box is designed for longer distances and extra source device control than the IR Repeater Box.

2. APPLICATIONS

- /// TV sales displays in consumer electronic stores
- /// Home theater installations
- /// Lecture room display
- /// Home entertainment

3. PACKAGE CONTENTS

- /// 1×Infrared Extender
- /// 1×Infrared Repeater
- /// 1×IR Extender (for Infrared Repeater)
- /// 5×Blasters (3 for Infrared Extender, 2 for Infrared Repeater)
- /// 1×5V DC Power Adaptor (for Infrared Repeater)
- /// Operation Manual

4. SYSTEM REQUIREMENTS

IR controlledable source equipment (e.g. DVD or Blu-ray players) and CAT5 cable.

5. FEATURES

- /// Supports up to 5 outputs (3 for Infrared Extender, 2 for Infrared Repeater)
- /// Control source devices anywhere within 250 m, can be run through walls and ceilings
- /// Transmits infrared signals only
- /// It allows the use of existing remote controls
- /// Only one IR Receiver is needed
- /// IR Receiver's frequency range is 30~50 kHz

6. OPERATION CONTROLS AND FUNCTIONS

6.1 Transmitter Front and Rear Panels

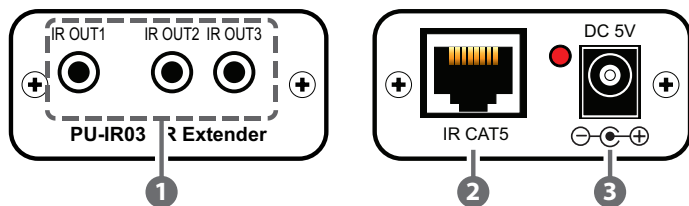

1 IR OUT1/2/3

Connect to the supplied IR blaster cables (up to 2 metres) for IR signal transmission. Place the IR blaster in direct line-of-sight of the equipment to be controlled.

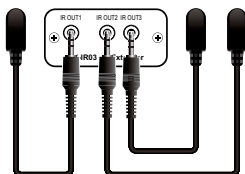

2 IR CAT5

Connect to the IR receiver with a CAT5 cable.

3 DC 5V

Plug the supplied 5 V DC power supply into the unit and connect the adaptor to an AC wall outlet.

Note: Connect the supplied power adapter to the IR repeater only. The two units can be used at the same time via a single power supply.

6.2 Receiver Front and Rear Panels

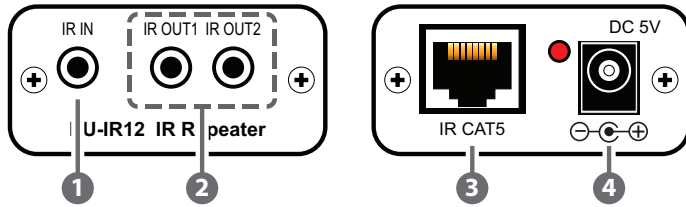

1 IR IN

Connect to the supplied IR extender cable (up to 2 metres) for IR signal reception. Ensure that the remote being used is within the direct line-of-sight of the IR extender.

2 IR OUT1/2

Connect to the supplied IR blaster cables (up to 2 metres) for IR signal transmission. Place the IR blaster in direct line-of-sight of the equipment to be controlled.

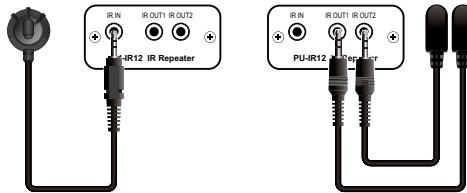

3 IR CAT5

Connect to the IR transmitter with a CAT5 cable.

4 DC 5V

Plug the 5 V DC power supply into the unit and connect the adaptor to an AC wall outlet.

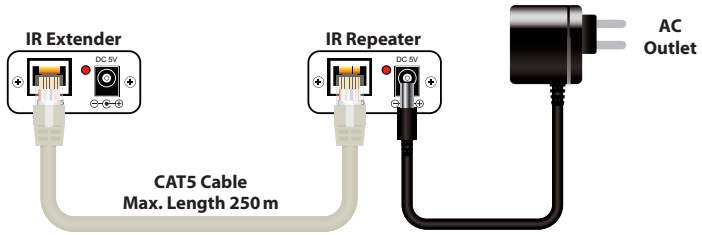

Note: Please note that when plugging in the blaster and extender cable incorrectly may damage or burn both the cables.

6.3 IR Cable Pin Definition

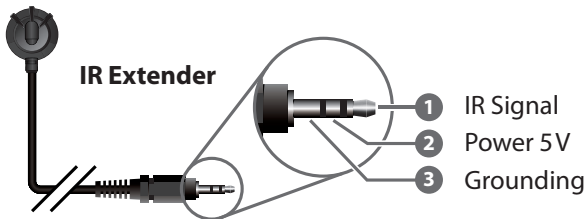
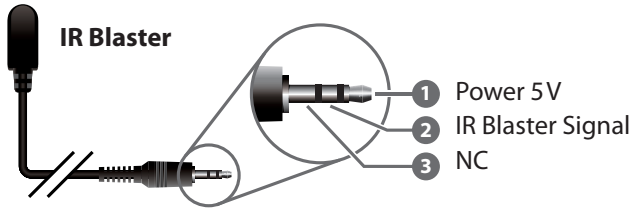

6.4 IR Phone Jack Pin Definition

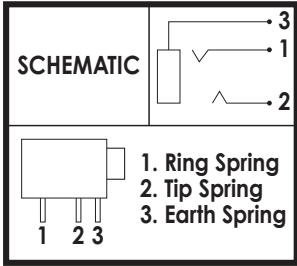

6.5 IR IN Pin Assignment

PIN	ASSIGNMENT
1 (Ring spring)	Power 5V
2 (Tip spring)	IR signal
3 (Earth spring)	GND

6.6 IR OUT Pin Assignment

PIN	ASSIGNMENT
1 (Ring spring)	IR Blaster Signal
2 (Tip spring)	Power 5V
3 (Earth spring)	IR Blaster signal

6.7 RJ45 Pin Assignment

PIN	ASSIGNMENT
1	GND
2	GND
3	GND
4	IR Blaster Signal
5	IR Blaster Signal
6	GND
7	Power
8	Power

7. CONNECTION DIAGRAM

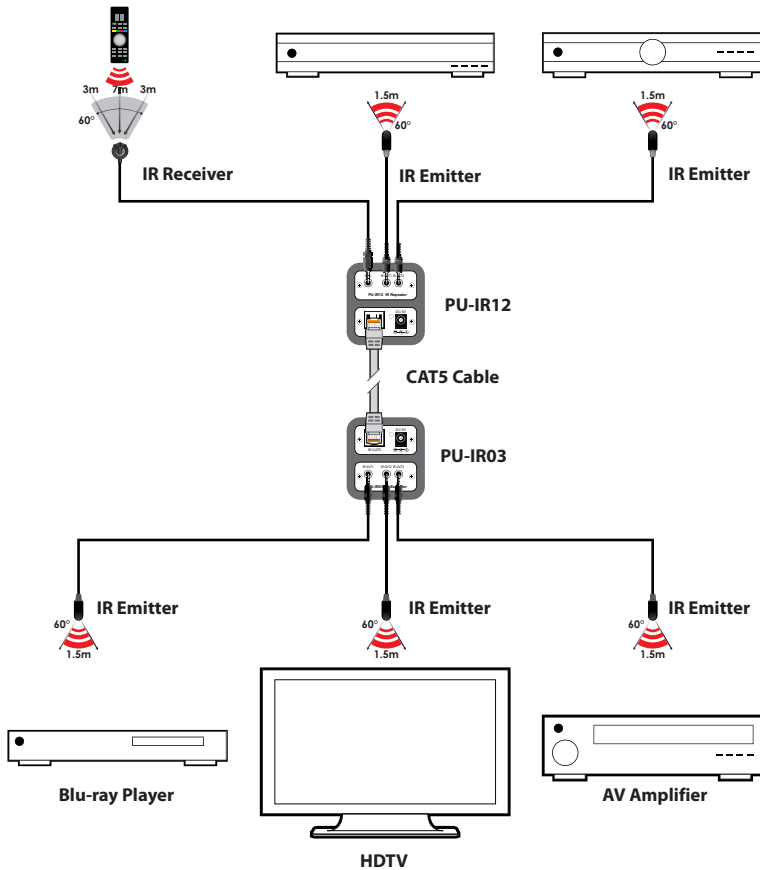

Note:

1. The IR blaster cable distance is up to 1.5 metres. Ensure that the remote being used is within the direct line-of-sight of the IR extender.
2. The IR extender cable distance is up to 7 metres. Place the IR blaster in direct line-of-sight of the equipment to be controlled.

8. SPECIFICATIONS

Transmitter

Input Port 1×CAT5e
Output Ports 3×IR Blaster

Receiver

Input Port 1×IR Extender
Output Ports 2×IR Blaster, 1×CAT5
Power Supply 5V/1 A DC (US/EU standards, CE/FCC/UL certified)
ESD Protection Human body model:

±10 kV (air-gap discharge)

±6 kV (contact discharge)

Dimensions 62 mm(W) × 50 mm (D) × 23 mm (H)/each

Weight 78g/each

Chassis Material Aluminum

Silkscreen Colour Silver

Operating Temperature 0°C~40°C / 32°F~104°F

Storage Temperature -20°C~60°C/-4°F~140°F

Power Consumption 0.5W

Relative Humidity 20~60% RH (non-condensing)

9. ACRONYMS

ACRONYM	COMPLETE TERM
CAT5	Category 5 Cable
DC	Direct Current
GND	Ground
IR	Infrared



CYP (UK) Ltd., Unit 7, Shepperton Business Park, Govett Avenue, Shepperton,
Middlesex, TW17 8BA

Tel: +44 (0) 20 3137 9180 | Fax: +44 (0) 20 3137 6279

Email: sales@cypeurope.com

www.cypeurope.com

v2.00